



**VALVOLE ESPANSIONE
TUBI ORIFIZIO**

**EXPANSION VALVES
ORIFICE TUBE**

03

VALVOLE ESPANSIONE-TUBI ORIFIZIO PER APPLICAZIONI ORIGINALI ORIGINAL EXPANSION-ORIFICE TUBE VALVE APPLICATIONS

TECHNICAL INF.

VALVOLE ESPANSIONE A BLOCCHETTO - BLOCK EXPANSION VALVE

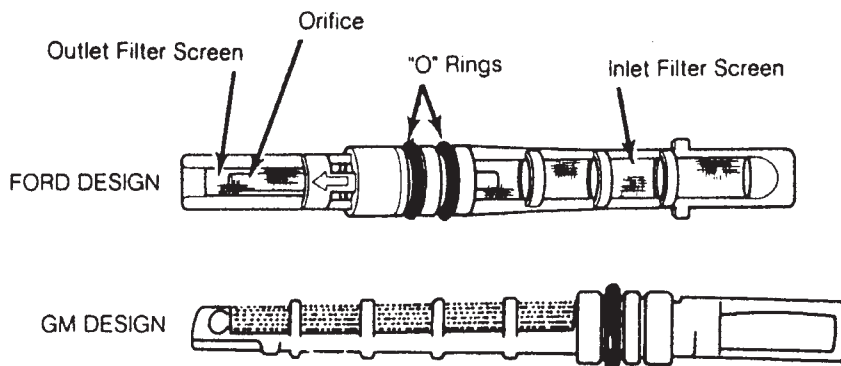
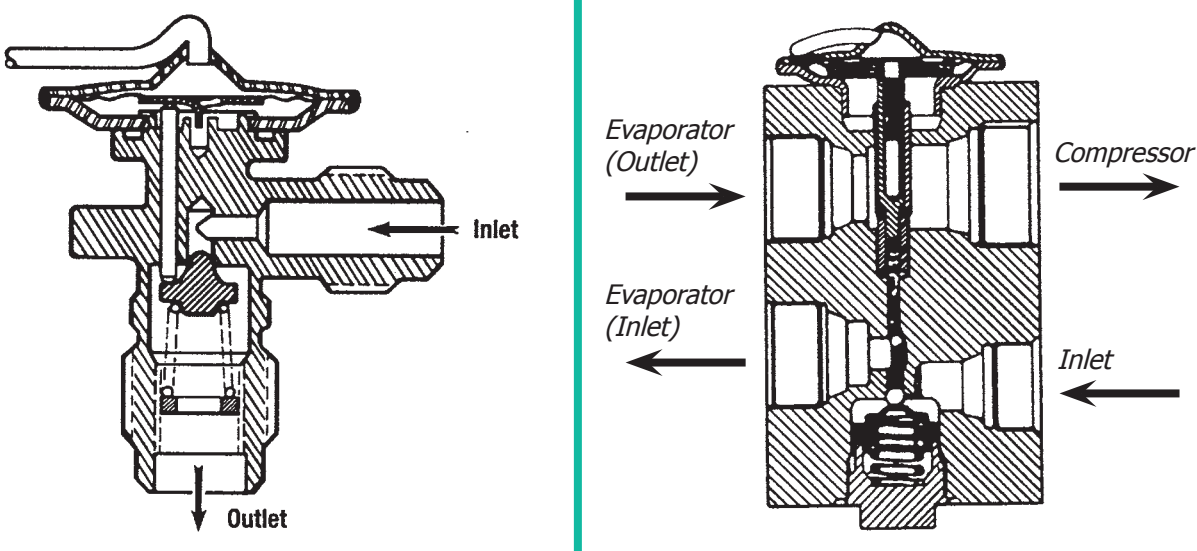
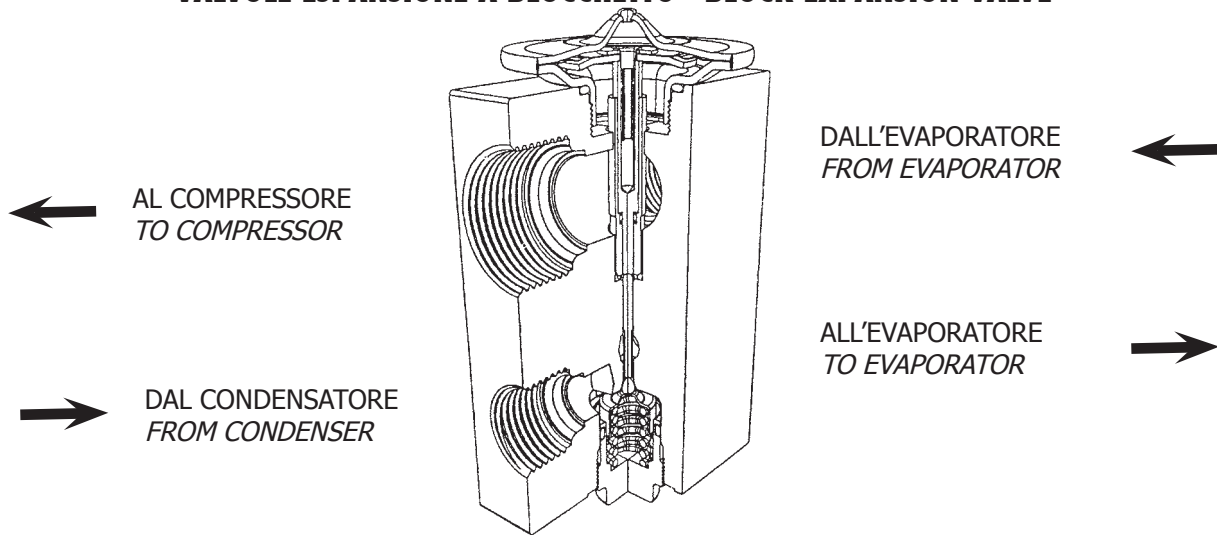

**O.E.****PAG****ALFA ROMEO**

145	Restyling 99	60779485	99 >		1212114	220
145	Boxer	60810249			1212005	220
145	T.S Gamma 97	60813905	97 >		1212058	220
146	Boxer	60810249			1212005	220
146	T.S Gamma 97	60813905	97 >		1212058	220
155		60810249			1212005	220
156		60779304			1212057	220
164		60811831		1212002		220
166		60813905			1212058	220
GTV		60779304	98 >		1212057	220
SPIDER		60779304	98 >		1212057	220

AUDI

AUDI	R12	443271191			1212005	220
AUDI	R134a	443271191A			1212173	220
AUDI	R134a	8A0820177AA - 4B0820177			1212044	220
A2		8E0820177	00 >		1212175	220
A3		6N0820679A			1212072	220
A3		1K0820679	05.03 >		1212076	220
A4		8E0820177	00 >		1212175	220
A6		8E0820177	00 >		1212175	220
A8		8E0820177	00 >		1212175	220

BMW

3ª serie E21		64511354379	77 > 83	1212106		221
3ª serie E21		64511372077	77 > 83	1212105		220
3ª serie E30		64511372503			1212104	221
3ª serie E36		64118384379	90 >		1212110	221
3ª serie E36		64118372436	90 >		1212110	221
3ª serie E36		64118361917	90 >		1212110	221
3ª serie E36		64118362851	94 >		1212150	221
3ª serie E46	318i - 320i - 320D - 323i	64118372773	02.98 > 09.98		1212200	221
3ª serie E46	316i - 318i - 320i - 320D 323i - 328i	64118381504	09.98 > 99		1212201	221
3ª serie E46	316i - 318i - 320i - 320D 323i - 328i - 330i - 330ix 330Dx 330D	64116904437	99 > 06.00 > 10.99 >		1212202	221
5ª serie E12		64511372077	76 > 83	1212105		220
5ª serie E12		64511354379	76 > 83	1212106		221
5ª serie E28		64511372077		1212105		2
5ª serie E34		64118362851			1212150	



O.E.



PAG

BMW

5ª serie E39	64118371459	95 >		1212109	221
6ª serie E24	64511372077	82	1212105		220
6ª serie E24	64511354379	82	1212106		221
6ª serie E24	64501377051			1212150	221
6ª serie E24	64501380506			1212150	221
6ª serie E24	64501468479			1212150	221
7ª serie E23	64111363581	77 > 86		1212108	221
7ª serie E32	64118362851	86 > 94		1212150	221
7ª serie E38	64118371459	96 >		1212109	221
7ª serie E38	64118362851			1212150	221
8ª serie E31	64118362851			1212150	221
Z3	64118362851			1212150	221
BMW	MODEL			1212010	218
BMW	MODEL			1212024	221

CATERPILLAR

CATERPILLAR	MODEL			1212160	221

CHRYSLER

CHRYSLER	MODEL			1212174	221

CITROËN

BERLINGO	6461G2			1212080	222
C2	6461H9			1212090	222
C3	6461H9			1212090	222
C5	6461H2			1212132	222
C8	6461H7			1212132	222
EVASION - MONOVOLUME	9613627780			1212080	222
PICASSO	6461G5			1212055	222
PICASSO	6461J0			1212045	222
SAXO	6461G2			1212080	222
XANTIA	ALL (Fix. Compr)	6461G1 - 6461F6		1212082	222
XANTIA	ALL (Vdc. Compr)	95667989		1212081	222
XSARA	6461G2	> 98		1212080	222
XSARA	6461G9	99 >		1212132	222
XSARA	6461G3			1212055	222
ZX	6461G2			1212080	222

DAF

95	7032102299			1212215	222



O.E.



PAG

DEUTZ						
DEUTZ	MODEL	512150802				1212065 222
FIAT						
BARCHETTA		46721906				1212056 223
BRAVA-BRAVO		46722498				1212058 222
BRAVA-BRAVO	1.2 - 1.6 - 1.8 16v G.98	46722498				1212058 222
BRAVA-BRAVO	1910 JTD G.98	46721906				1212056 223
BRAVA-BRAVO	1910 TD 100cv G.98	46722498				1212058 222
BRAVA-BRAVO	1910 TD 75 cv G.98	46722498				1212058 222
BRAVA-BRAVO	2.0 20V G.98	46722498				1212058 222
COUPÈ		82479336	93 > 96			1212005 222
COUPÈ	G.96	82479336	96 >			1212005 222
COUPÈ	G.97	46722498				1212058 222
CROMA		7794459			1212022	222
DUCATO	Bz G.94	46721906	94 >			1212056 223
DUCATO	Diesel G.94	46721906				1212056 223
MAREA	Bz / Diesel	46722498				1212058 222
MULTIPLA		60815236				1212114 223
PUNTO		46721906				1212056 223
PUNTO	G.97	46721906	97			1212056 223
PUNTO 188	MMC	46722958	99 >			1212230 223
PUNTO 188	VALEO		99 >			1212231 223
PUNTO CABRIO		46721906				1212056 223
SCUDO		9613627780				1212080 223
STILO		46723469				1212232 223
TEMPRA	1.4 - 1.6 - 1.8 - 2.0	82479336	93 > 96			1212005 222
TEMPRA	D - TD	82479336	93 > 96			1212005 222
TIPO	1.4 - 1.6 - 1.8 - 2.0	82479336	93 > 95			1212005 222
TIPO	D - TD	82479336	93 > 95			1212005 222
ULISSE		9613627780				1212080 223
FORD						
GALAXI		1019678 - 95NW19849AB				1212113 224
FORD	MODEL	6899284				1212017 223
FORD	MODEL					1212024 224
FORD	MODEL	3856040 - F5UH19D990AA				1212170 223
FORD	MODEL	3306861				1212171 223
FORD	MODEL	3856040				1212172 223
FORD	MODEL	3456455 - 3887675				1212005 223
FORD	MODEL	3887675				1212168 223



O.E.



PAG

HURLIMAN

HURLIMAN	MODEL	512150802				1212065	224
-----------------	-------	-----------	--	--	--	----------------	-----

IVECO

TRUCKS						1212210	224
---------------	--	--	--	--	--	----------------	-----

JAGUAR

JAGUAR	MODEL	CAA5934 - CAC2423				1212002	224
JAGUAR	MODEL	RTC693				1212002	224
JAGUAR	MODEL					1212024	224
JAGUAR	MODEL	CAC8169				1212052	224
JAGUAR	MODEL	RTC693				1212106	224

JEEP

JEEP						1212174	224
-------------	--	--	--	--	--	----------------	-----

JOHN DEERE

serie 6000		EXV924				1212102	224
serie 7000		EXV924				1212102	224
JOHN DEERE	MODEL	RE174764				1212099	224

LAMBORGHINI Tractor

LAMBORGHINI	MODEL	512150802				1212065	225
--------------------	-------	-----------	--	--	--	----------------	-----

LANCIA

DEDRA		82479336				1212005	225
DELTA		82479336				1212005	225
DELTA		82479336				1212005	225
KAPPA		46721108	> 98			1212054	225
KAPPA		46722498	98 >			1212058	225
LIBRA		46722498				1212058	225
THEMA		7794459				1212022	225
Y		46721906				1212056	225
ZETA		9613627780				1212080	225

MAN

F90		81619670010				1212220	225
F200		81619670010				1212220	225
M90		81619670010				1212220	225



O.E.



PAG

NISSAN

NISSAN	MODEL	27624 - H7300 - H7500		1212006		226
NISSAN	MODEL				1212135	226

OPEL

ASTRA F		1618043 - 52464384			1212068	227
ASTRA G		1618131 - 52478992	98 >		1212155	227
CALIBRA A		1618043 - 52464384			1212068	227
CORSA		1618043 - 52464384			1212068	227
CORSA C	(VAUXHALL 9196195)	1618192 - 9196195	00 >		1212055	227
MERIVA		1618291 - 93175275			1212067	227
OMEGA B		1618043 - 52464384			1212068	227
VECTRA A		1618043 - 52464384			1212068	227
VECTRA B	(T 2900)	1618057			1212070	227
VECTRA B	(J 2900)		04.97 >		1212069	227
OPEL	MODEL	1845404 - 52460909			1212005	227
ZAFIRA		1618131 - 52478992	98 >		1212155	227

PEUGEOT

106		6461G2			1212080	227
206		6461G3			1212055	227
306		6461G3	> 02.99		1212055	227
306	CARBURATORE	646197 - 7434611002	93 > 94		1212059	227
306		6461G2	02.99 >		1212080	227
307		6461H5 - 6461H6			1212045	227
406		6461G2			1212080	227
406		6461G8			1212070	227
806		6461G2			1212080	227
EPERT		6461G2			1212080	227
PARTNER		6461G2			1212080	227

PORSCHE

901		901573915		1212106		228
911		91157392500		1212105		228
928		92857312305 - 92857022300			1212112	228
986		92857312305 - 92857022300			1212112	228
986					1212047	228
996					1212047	228
CAYENNE		7L0820679	03 > 05		1212050	228
CAYENNE		7L0820679A	05 >		1212050	228

**O.E.****PAG****SEAT**

AROSA	6N0820679A				1212072	230
CORDOBA	1H0820679A				1212027	231
IBIZA	1H0820679A				1212027	231
NEW IBIZA	6Q0820679	00 >			1212180	230
TOLEDO	1K0820679	03.04 >			1212076	231

SKODA

NEW FELICIA	6Q0820679	00 >			1212180	230
OCTAVIA	6N0820679A				1212072	231
OCTAVIA	1K0820679	05.04 >			1212076	231

SUZUKI

GRAN VITARA					1212015	231
VITARA					1212015	231

TOYOTA

ECHO	447500-1620				1212245	231
TOYOTA	R134a MODEL 88515-20100				1212060	231
TOYOTA	R12 MODEL 88515-33010				1212061	231

VOLKSWAGEN

NEW BEETLE	6N0820679C	99 >			1212075	231
BORA	6N0820679C	99 >			1212075	231
CADDY	1K0820679	02.04 >			1212076	232
CARAVEL	701820679				1212055	231
GOLF II	191820679				1212108	231
GOLF III	1H0820679A	> 96			1212027	231
GOLF III	6N0820679A	96 >			1212072	231
GOLF IV	6N0820679A	96 >			1212072	231
GOLF IV	6N0820679C	99 >			1212075	231
GOLF V	1K0820679	10.03 >			1212076	232
LUPO	6N0820679C	99 >			1212075	231
JETTA CHINA	1H0820679A	> 96			1212027	231
JETTA II	191820679				1212108	231
PASSAT III	191820679				1212108	231
PASSAT IV	1H0820679A	> 96			1212027	231
PASSAT IV	6N0820679A	96 >			1212072	231
PASSAT V	8A0820177AA - 4B0820177				1212044	231
POLO	6N0820679C	99 >			1212075	231
POLO	6N0820679A	96 >			1212072	231
NEW POLO CLASSIC	6Q0820679	00 >			1212180	232

VALVOLE ESPANSIONE UNIVERSAL UNIVERSAL EXPANSION VALVES



UNIVERSAL

REF 1212013

F. O.RING 1,5 TONS

IN LET OUT LET RETURN SUCTION
3/8" O.RING 1/2" O.RING 1/2" O.RING 5/8" O.RING



UNIVERSAL

REF 1212052

F. O.RING 2 TONS

IN LET OUT LET RETURN SUCTION
3/8" O.RING 1/2" O.RING 1/2" O.RING 5/8" O.RING



UNIVERSAL

REF 1212010

F. O.RING 2 TONS

IN LET OUT LET RETURN SUCTION
3/8" O.RING 1/2" O.RING 1/2" O.RING 5/8" O.RING



UNIVERSAL

**MB
BMW
FORD
JAGUAR
SAAB**

**W124 - W201
MODEL
MODEL
MODEL
9000**

REF 1212024

FLANGIA - FLANGE MINI BLOCK 2 TONS

IN LET OUT LET RETURN SUCTION
3/8" TUBE "0" 1/2" TUBE "0" 5/8" TUBE "0" 3/4" TUBE "0"



UNIVERSAL

REF 1212045

FLANGIA - FLANGE MINI BLOCK 1,5 TONS

IN LET OUT LET RETURN SUCTION
3/8" TUBE "0" 1/2" TUBE "0" 5/8" TUBE "0" 3/4" TUBE "0"

VALVOLE ESPANSIONE UNIVERSAL UNIVERSAL EXPANSION VALVES

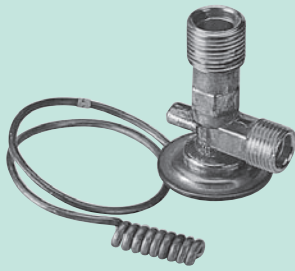

REF 1212004

C / EQUALIZZATORE INTERNO
W / INTERNAL EQUALIZER
O.RING - 2 TONS

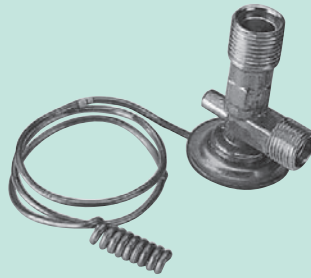

REF 1212048

C / EQUALIZZATORE INTERNO
W / INTERNAL EQUALIZER
O.RING - 1,5 TONS

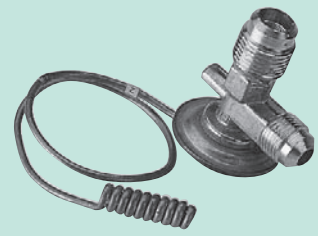

REF 1212006

C / EQUALIZZATORE INTERNO
W / INTERNAL EQUALIZER
CONO / FLARE - 1,5 TONS



REF 1212009

C / EQUALIZZATORE ESTERNO MEDIO
W / MEDIUM EXTERNAL EQUALIZER
O.RING - 1,5 TONS

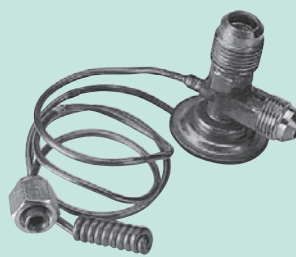

REF 1212014

C / EQUALIZZATORE ESTERNO LUNGO
W / LONG EXTERNAL EQUALIZER
CONO / FLARE - 2 TONS



REF 1212008

C / EQUALIZZATORE ESTERNO
LUNGO
W / LONG EXTERNAL EQUALIZER
CONO / FLARE - 1,5 TONS

VALVOLE ESPANSIONE-TUBI ORIFIZIO PER APPLICAZIONI ORIGINALI ORIGINAL EXPANSION-ORIFICE TUBE VALVE APPLICATIONS

ALFA ROMEO

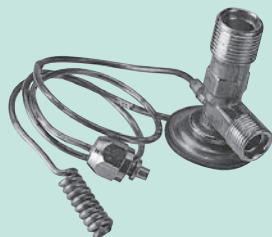

REF 1212002

ALFA ROMEO MODEL

C/EQUALIZZATORE ESTERNO MEDIO
W/MEDIUM EXTERNAL EQUALIZER

O.RING 2 TONS

ALFA ROMEO

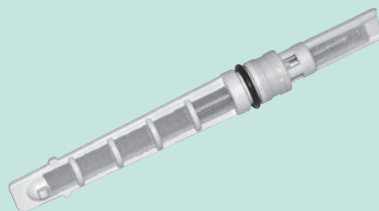

REF 1212005 BIANCO - WHITE

145
146
155

ALFA ROMEO



REF 1212114

145 99 >

ALFA ROMEO



REF 1212058 TGK

145 97 >
146 97 >
166

ALFA ROMEO



REF 1212057 TGK

156
GTV
SPIDER

AUDI

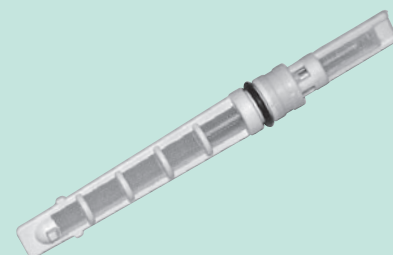

REF 1212005 BIANCO - WHITE

AUDI MODEL R12

AUDI

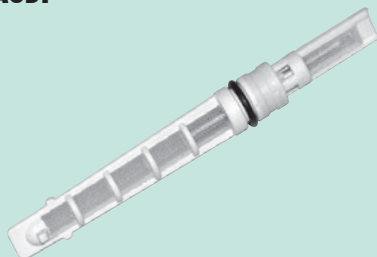

REF 1212044 GIALLO - YELLOW

AUDI MODEL R134a

AUDI

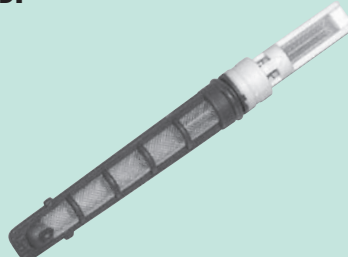

REF 1212173 GRIGIO - GRAY

AUDI MODEL

AUDI

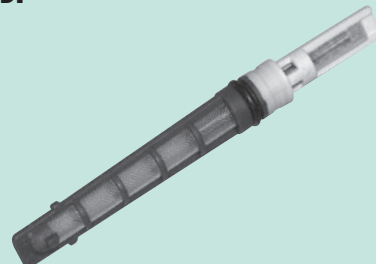

REF 1212175 ARANCIONE - ORANGE

A2
A4
A6
A8

AUDI



REF 1212072 TGK

A3

AUDI



REF 1212076 TGK

A3 05.03>

BMW

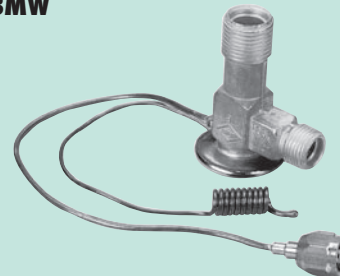

REF 1212105

3ª serie E21 - 5ª serie E12 / E28

6ª serie E24

VALVOLE ESPANSIONE-TUBI ORIFIZIO PER APPLICAZIONI ORIGINALI ORIGINAL EXPANSION-ORIFICE TUBE VALVE APPLICATIONS

BMW

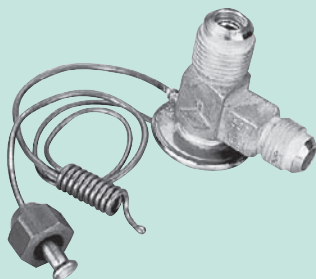

REF 1212106

3ª serie E21 - 5ª serie E12
6ª serie E24

BMW



REF 1212110

3ª serie E36

BMW



REF 1212104

3ª serie E30

BMW



REF 1212201

3ª serie E46

BMW



REF 1212150

3ª serie E36
5ª serie E34
6ª serie E24
7ª serie E32 - 7ª serie E38
8ª serie E31 - Z3

BMW



REF 1212200

3ª serie E46

BMW



REF 1212202

3ª serie E46

BMW



REF 1212108

7ª serie E23

BMW



REF 1212109

5ª serie E39
7ª serie E38

BMW



REF 1212024

BMW

TGK
MODEL

CATERPILLAR



REF 1212160

MODEL



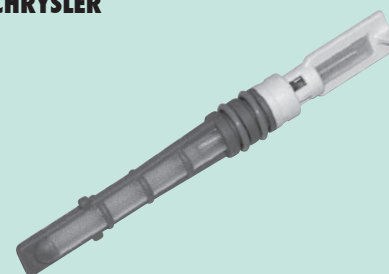







CHRYSLER







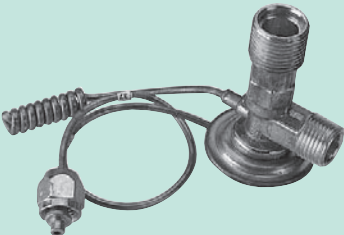
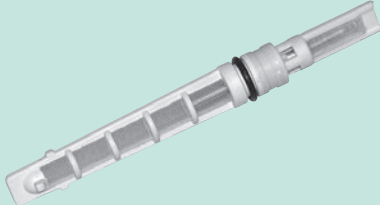

REF 1212174

PORPORA - PURPLE
MODEL







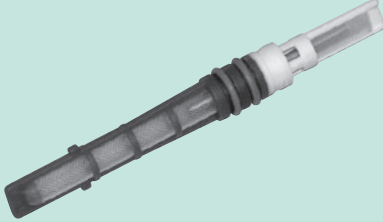
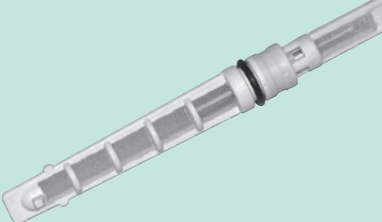
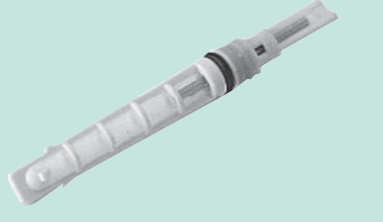
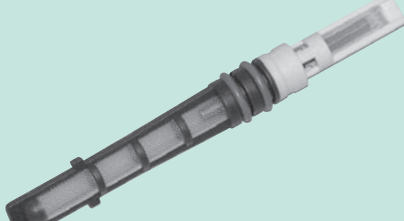
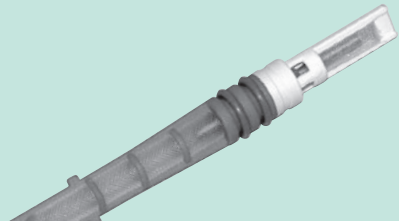
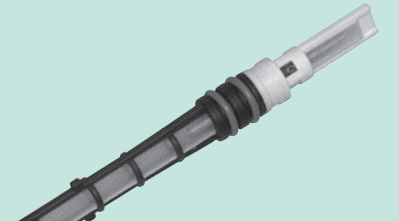

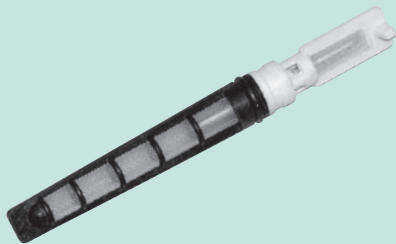

VALVOLE ESPANSIONE-TUBI ORIFIZIO PER APPLICAZIONI ORIGINALI ORIGINAL EXPANSION-ORIFICE TUBE VALVE APPLICATIONS

<p>CITROËN</p>  <p>REF 1212080 TGK</p> <p>BERLINGO EVASION SAXO XSARA > 98 ZX</p>	<p>CITROËN</p>  <p>REF 1212081 TGK</p> <p>XANTIA (VDC CMPR) COMPRESSORE CILINDRATA FISSA <i>FIX COMPRESSOR</i></p>	<p>CITROËN</p>  <p>REF 1212090 TGK</p> <p>C2 C3</p>
<p>CITROËN</p>  <p>REF 1212082 TGK</p> <p>XANTIA (FIX. CMPR) COMPRESSORE CILINDRATA VARIABILE <i>VARIABLE COMPRESSOR</i></p>	<p>CITROËN</p>  <p>REF 1212132 TGK</p> <p>XSARA 99 > C5 C8</p>	<p>CITROËN</p>  <p>REF 1212045 TGK</p> <p>PICASSO</p>
<p>CITROËN</p>  <p>REF 1212055 TGK</p> <p>XSARA PICASSO</p>	<p>DAF</p>  <p>REF 1212215 TGK</p> <p>95</p>	<p>DEUTZ</p>  <p>REF 1212065 MODEL</p>
<p>FIAT</p>  <p>REF 1212022</p> <p>CROMA C/EQUALIZZATORE ESTERNO CORTO W/SHORT EXTERNAL EQUALIZER O.RING - 2 TONS</p>	<p>FIAT</p>  <p>REF 1212005 BIANCO - WHITE</p> <p>COUPÈ 93 > 96 TIPO TEMPRA</p>	<p>FIAT</p>  <p>REF 1212058 TGK</p> <p>BRAVO/BRAVA COUPÈ 97 MAREA</p>

VALVOLE ESPANSIONE-TUBI ORIFIZIO PER APPLICAZIONI ORIGINALI ORIGINAL EXPANSION-ORIFICE TUBE VALVE APPLICATIONS

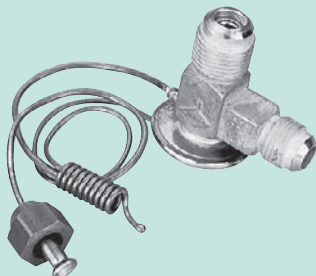
<p>FIAT</p>  <p>REF 1212056 TGK</p> <p>BARCETTA BRAVO/BRAVA DUCATO PUNTO PUNTO</p> <p>G. 98 G. 94 G. 97</p>	<p>FIAT</p>  <p>REF 1212114</p> <p>MULTIPLA</p>	<p>FIAT</p>  <p>REF 1212231 TGK</p> <p>PUNTO 188</p> <p>valeo</p>
<p>FIAT</p>  <p>REF 1212232 TGK</p> <p>STILO</p>	<p>FIAT</p>  <p>REF 1212230 TGK</p> <p>PUNTO 188</p> <p>MMC</p>	<p>FIAT</p>  <p>REF 1212080 TGK</p> <p>SCUDO ULISSE</p>
<p>FORD</p>  <p>REF 1212171 ARANCIONE - ORANGE</p> <p>FORD MODEL</p>	<p>FORD</p>  <p>REF 1212005 BIANCO - WHITE</p> <p>FORD MODEL</p>	<p>FORD</p>  <p>REF 1212017 BLU - BLUE</p> <p>FORD MODEL</p>
<p>FORD</p>  <p>REF 1212172 MARRONE - BROWN</p> <p>FORD MODEL</p>	<p>FORD</p>  <p>REF 1212168 VERDE - GREEN</p> <p>FORD MODEL</p>	<p>FORD</p>  <p>REF 1212170 ROSSO - RED</p> <p>FORD MODEL</p>

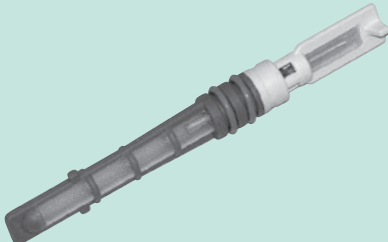
VALVOLE ESPANSIONE-TUBI ORIFIZIO PER APPLICAZIONI ORIGINALI ORIGINAL EXPANSION-ORIFICE TUBE VALVE APPLICATIONS

<p>FORD</p>  <p>REF 1212113 GALAXY</p>	<p>FORD</p>  <p>REF 1212024 FORD</p> <p>TGK MODEL</p>	<p>GENERAL MOTOR</p>  <p>REF 1212169 GM</p> <p>BIANCO & NERO BLACK & WHITE</p> <p>MODEL</p>
<p>HURLIMAN</p>  <p>REF 1212065 MODEL</p>	<p>IVECO</p>  <p>REF 1212210 TRUCKS</p>	<p>JAGUAR</p>  <p>REF 1212002 JAGUAR</p> <p>C/EQUALIZZATORE ESTERNO MEDIO W/MEDIUM EXTERNAL EQUALIZER</p> <p>O.RING - 2 TONS</p> <p>MODEL</p>
<p>JAGUAR</p>  <p>REF 1212024 JAGUAR</p> <p>TGK MODEL</p>	<p>JAGUAR</p>  <p>REF 1212106 JAGUAR</p> <p>MODEL</p>	<p>JAGUAR</p>  <p>REF 1212052 JAGUAR</p> <p>MODEL</p>
<p>JEEP</p>  <p>REF 1212174 JEEP</p> <p>PORPORA - PURPLE</p> <p>MODEL</p>	<p>JOHN DEERE</p>  <p>REF 1212102 6000 7000</p>	<p>JOHN DEERE</p>  <p>REF 1212099 JOHN DEERE</p> <p>TGK MODEL</p>

VALVOLE ESPANSIONE-TUBI ORIFIZIO PER APPLICAZIONI ORIGINALI ORIGINAL EXPANSION-ORIFICE TUBE VALVE APPLICATIONS

**LAMBORGHINI
Tractor**



REF 1212065

MODEL

LANCIA

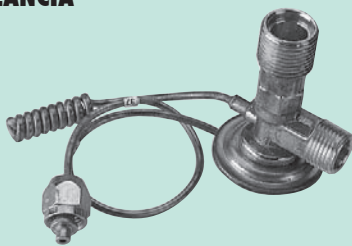

RE F 1212022

THEMA

C / EQUALIZZATORE ESTERNO CORTO
W/SHORT EXTERNAL EQUALIZER
O.RING - 2 TONS

LANCIA

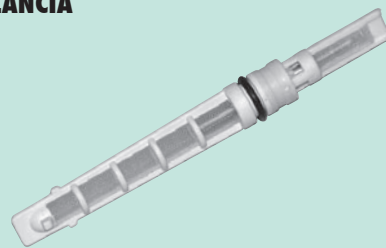

REF 1212005 BIANCO - WHITE

DEDRA

DELTA

DELTA

LANCIA



REF 1212054

TGK

KAPPA > 98

LANCIA



REF 1212058

TGK

KAPPA 98 >

LIBRA

LANCIA



REF 1212056

TGK

Y

LANCIA



REF 1212080

TGK

ZETA

MAN



REF 1212220

F90

F200

M90

M2000

MASSEY FERGUSON



REF 1212121

TGK

MASSEY FERGUSON

2,5 TONS

MCC - SMART



REF 1212084

TGK

SMART

MERCEDES

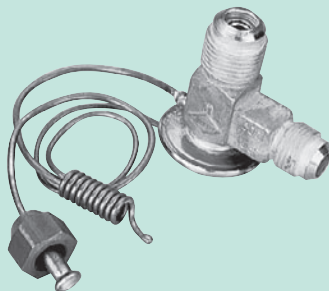

REF 1212106

W115

MERCEDES



REF 1212052

W123

VALVOLE ESPANSIONE-TUBI ORIFIZIO PER APPLICAZIONI ORIGINALI ORIGINAL EXPANSION-ORIFICE TUBE VALVE APPLICATIONS

MERCEDES



REF 1212100

W124
W201

MERCEDES



REF 1212101

W126

MERCEDES



REF 1212111

R129 SL
W140

MERCEDES

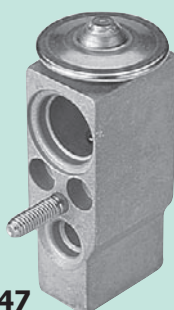

REF 1212047

TGK

W202
W210
R170 - SLK
SPRINTER
VITO

MERCEDES



REF 1212085

TGK

CLASSE A

MERCEDES



REF 1212024

TGK

W124
W201

MERCEDES



REF 1212116

W203 classe C
W211 classe E
W220 classe S

MERCEDES



REF 1212115

W203 classe C
W220 classe S

NEW HOLLAND



REF 1212120

460
serie TM - TS

NEW HOLLAND



REF 1212056

TGK
MODEL

NISSAN

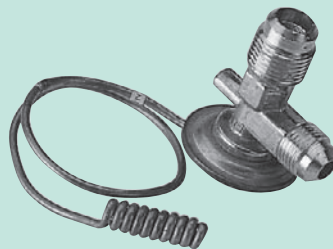

REF 1212006

MODEL

C / EQUALIZZATORE INTERNO
W / INTERNAL EQUALIZER
FLARE 1,5 TONS

NISSAN

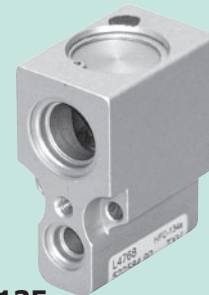

REF 1212135

TGK
MODEL

VALVOLE ESPANSIONE-TUBI ORIFIZIO PER APPLICAZIONI ORIGINALI ORIGINAL EXPANSION-ORIFICE TUBE VALVE APPLICATIONS

PORSCHE

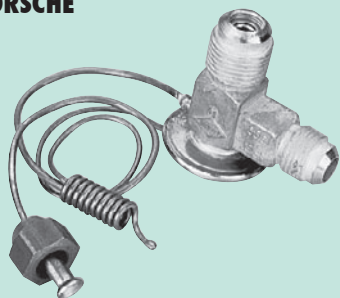

REF 1212106

901

PORSCHE

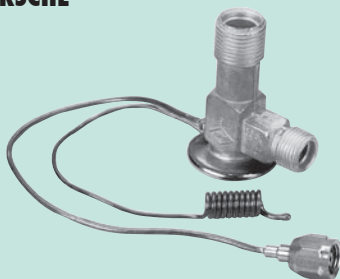

REF 1212105

911

PORSCHE



REF 1212112

**928
986**

PORSCHE

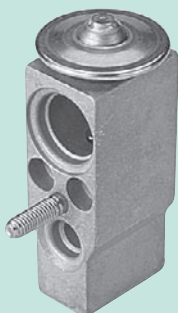

REF 1212047

TGK

**986
996**

PORSCHE



REF 1212050

TGK

CAYENNE

RENAULT



REF 1212052

21

RENAULT

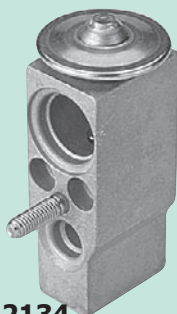

REF 1212134

TGK

CLIO 99 >

RENAULT

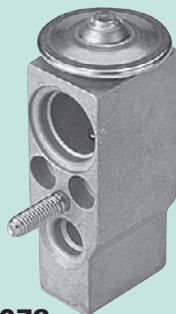

REF 1212078

TGK

KANGOO 98 >

RENAULT

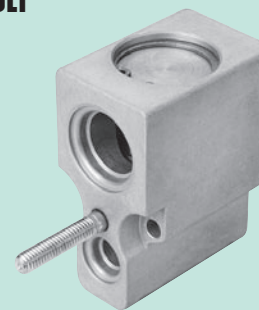

REF 1212133

TGK

CLIO

RENAULT



REF 1212083

TGK

**CLIO > 97
TWINGO**

RENAULT



REF 1212079

TGK

KANGOO > 98

RENAULT



REF 1212027

TGK

SAFRANE

**VALVOLE ESPANSIONE-TUBI ORIFIZIO PER APPLICAZIONI ORIGINALI
ORIGINAL EXPANSION-ORIFICE TUBE VALVE APPLICATIONS**

RENAULT



REF 1212074 **TGK**
MEGANE > 97
SCENIC > 97

RENAULT



REF 1212073 **TGK**
MEGANE > 97

RENAULT



REF 1212131 **TGK**
TWINGO

RENAULT



REF 1212132 **TGK**
MEGANE > 97
SCENIC > 97

RENAULT



REF 1212135 **TGK**
MODEL

RENAULT

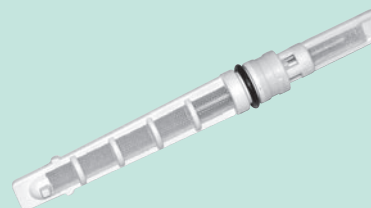

REF 1212044 GIALLO - YELLOW
RENAULT

ROVER



REF 1212071 **TGK**
200 Bz
400 Bz

ROVER



REF 1212077 **TGK**
200 D
400 D

ROVER



REF 1212109
L50

SAAB

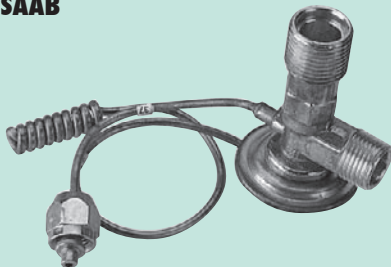

REF 1212022
900
C / EQUALIZZATORE ESTERNO CORTO
W / SHORT EXTERNAL EQUALIZER
O.RING - 2 TONS

SAAB











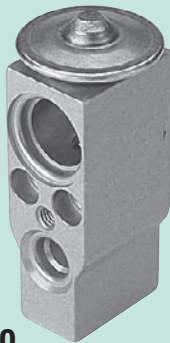
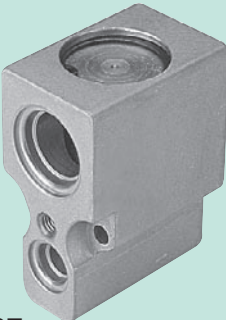

REF 1212046 **TGK**
640
900 (serie V4 - V6)

SAAB

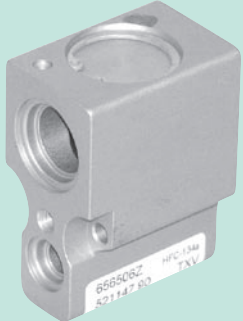

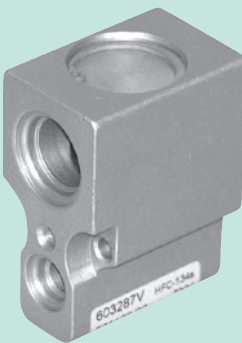
REF 1212024 **TGK**
SAAB MODEL

VALVOLE ESPANSIONE-TUBI ORIFIZIO PER APPLICAZIONI ORIGINALI ORIGINAL EXPANSION-ORIFICE TUBE VALVE APPLICATIONS

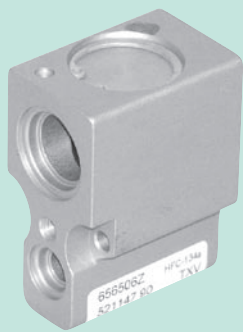
<p>SAAB</p>  <p>REF 1212280 TGK</p> <p>9.3</p>	<p>SAAB</p>  <p>REF 1212027 TGK</p> <p>9.5</p>	<p>SAME</p>  <p>REF 1212065 MODEL</p>
<p>SCANIA</p>  <p>REF 1212052</p> <p>143</p>	<p>SCANIA</p>  <p>REF 1212100</p> <p>144</p>	<p>SEAT</p>  <p>REF 1212072 TGK</p> <p>AROSA</p>
<p>SEAT</p>  <p>REF 1212113</p> <p>ALHAMBRA</p>	<p>SEAT</p>  <p>REF 1212027 TGK</p> <p>CORDOBA IBIZA</p>	<p>SEAT</p>  <p>REF 1212180 TGK</p> <p>NEW IBIZA</p>
<p>SEAT</p>  <p>REF 1212076 TGK</p> <p>ALTEA TOLEDO</p>	<p>SKODA</p>  <p>REF 1212180 TGK</p> <p>NEW FELICIA</p>	<p>SKODA</p>  <p>REF 1212072 TGK</p> <p>OCTAVIA</p>

VALVOLE ESPANSIONE-TUBI ORIFIZIO PER APPLICAZIONI ORIGINALI ORIGINAL EXPANSION-ORIFICE TUBE VALVE APPLICATIONS

VOLKSWAGEN



REF 1212076

TGK

CADDY
GOLF V
TOURAN

VOLKSWAGEN



REF 1212180

TGK

NEW POLO CLASSIC

VOLKSWAGEN



REF 1212113

SHARAN

VOLKSWAGEN



REF 1212104

VW

MODEL

VOLKSWAGEN



REF 1212015

TGK

TRANSPORTER T4 sanden A/C

VOLKSWAGEN

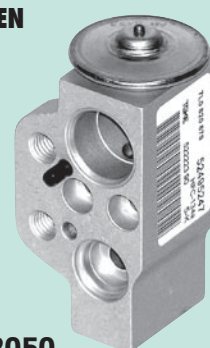

REF 1212050

TGK

TOUAREG

VOLVO

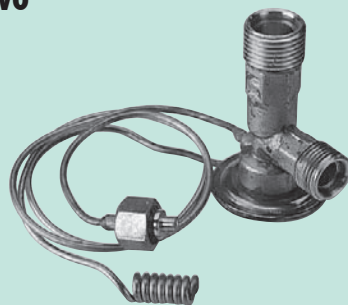

REF 1212028

VOLVO

MODEL

O.RING - C / EQUALIZZATORE ESTERNO
O.RING - W / EXTERNAL EQUALIZER

VOLVO

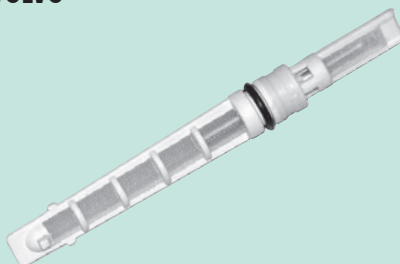

REF 1212044

GIALLO - YELLOW

VOLVO

R134a

VOLVO

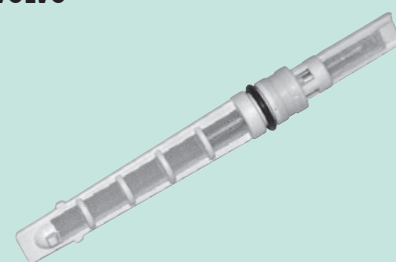

REF 1212005

BIANCO - WHITE

VOLVO

MODEL

VOLVO



REF 1212225

TRUCKS

VOLVO

VOLVO

VALVOLE ESPANSIONE-TUBI ORIFIZIO PER APPLICAZIONI ORIGINALI ORIGINAL EXPANSION-ORIFICE TUBE VALVE APPLICATIONS

TOTAL BOX KIT

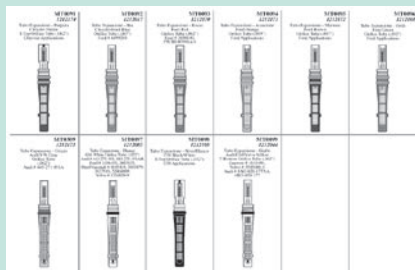

REF 1213283

KIT TUBI ESPANSIONE VEICOLI EUROPEI
ORIFICE TUBE KIT BOX FOR EUROPEAN VEHICLES

ACCESSORI - ACCESSORIES

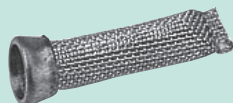

REF 1211050

FILTRINO A RETE per VALVOLA ESP. ANGOLO
EXPANSION VALVE SCREEN

ACCESSORI - ACCESSORIES

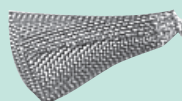

REF 1211051

FILTRINO A RETE per VALVOLA ESP. ANGOLO
EXPANSION VALVE SCREEN

ACCESSORI - ACCESSORIES

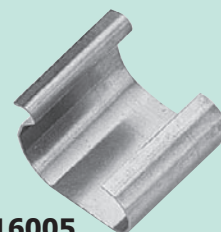

REF 1216005

MOLLETTA di FISSAGGIO BULBO
VALVOLA ESP.
FASTENING CLAMP EXPANSION VALVE

VALVOLE ESPANSIONE-TUBI ORIFIZIO PER APPLICAZIONI ORIGINALI ORIGINAL EXPANSION-ORIFICE TUBE VALVE APPLICATIONS

